

INSTRUCTION MANUAL

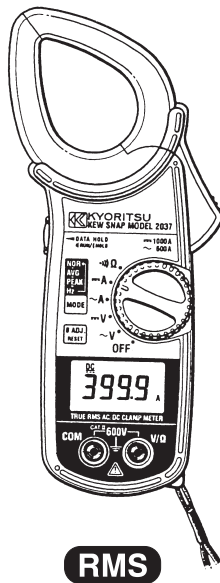

AC/DC DIGITAL CLAMP METER

KEW SNAP SERIES

KEW SNAP 2037

KYORITSU ELECTRICAL INSTRUMENTS WORKS, LTD., TOKYO, JAPAN

Table of contents

	Page
1. Safety Warnings	1
2. Features	4
3. Specifications	5
4. Instrument Layout	9
5. Preparation for Tests	12
6. Operating Instructions	
6-1 DC Current Measurement	13
6-2 AC Current Measurement	14
6-3 DC Voltage Measurement	15
6-4 AC Voltage Measurement	16
6-5 Resistance Measurement	17
6-6 Continuity Check	18
6-7 Frequency Measurement	19
6-8 Peak Measurement	20
6-9 Average Measurement	21
7. Other Functions	
7-1 Sleep	22
7-2 Data Hold	22
7-3 LoHz	22
8. Battery Replacement	23
9. Optional Accessories	24



1. Safety Warnings

○ This instrument has been designed and tested according to IEC Publication 61010 : Safety Requirements for Electronic Measuring Apparatus. This instruction manual contains warnings and safety rules which must be observed by the user to ensure safe operation of the instrument and retain it in safe condition. Therefore, read through these operating instructions before starting using the instrument.

WARNING

- Read through and understand instructions contained in this manual before starting using the instrument.
- Save and keep the manual handy to enable quick reference whenever necessary.
- Be sure to use the instrument only in its intended applications and to follow measurement procedures described in the manual.
- Be sure to understand and follow all safety instructions contained in the manual.

Failure to follow the above instructions may cause injury, instrument damage and/or damage to equipment under test.

○ The symbol  indicated on the instrument means that the user must refer to related parts in the manual for safe operation of the instrument. Be sure to carefully read the instructions following each  symbol in this manual.

 **DANGER** is reserved for conditions and actions that are likely to cause serious or fatal injury.

 **WARNING** is reserved for conditions and actions that can cause serious or fatal injury.

 **CAUTION** is reserved for conditions and actions that can cause minor injury or instrument damage.

○ Following symbols are used on the instrument and in the instruction manual. Attention should be paid to each symbol to ensure your safety.

△ Refer to the instructions in the manual.

▣ Indicates an instrument with double or reinforced insulation.

⚡ Indicates that this instrument can clamp on bare conductors when measuring a voltage corresponding to the applicable Measurement category, which is marked next to this symbol.

~ Indicates AC.

⎓ Indicates DC.

⏏ Indicates Earth.

△ DANGER

- Never make measurement on a circuit above 750VAC or 1000VDC.
- Do not attempt to make measurement in the presence of flammable gasses, fumes, vapor or dust. Otherwise, the use of the instrument may cause sparking, which can lead to an explosion.
- Transformer jaw tips are designed not to short the circuit under test. If equipment under test has exposed conductive parts, however, extra precaution should be taken to minimize the possibility of shorting.
- Do not exceed the maximum allowable input of any measurement range.
- Never open the battery compartment cover when making measurement.

△ WARNING

- Never attempt to make any measurement. If the instrument has any structural abnormality such as cracked case and exposed metal part.
- Do not turn the function selector switch with test leads connected to the instrument.
- Do not install substitute parts or make any modification to the instrument. Return the instrument to your distributor for repair or recalibration.
- Do not try to replace the batteries if the surface of the instrument is wet.
- Always switch off the instrument before opening the battery compartment cover for battery replacement.

⚠ CAUTION

- Make sure that the function selector switch is set to an appropriate position before making measurement.
- Always make sure to insert the plug of each lead fully into the appropriate terminal on the instrument.
- Be sure to set the function selector switch to the “OFF” position after use. When the instrument will not be in use for a long period of time, place it in storage after removing the batteries.
- Do not expose the instrument to the direct sun, extreme temperatures or dew fall.
- Use a damp cloth and detergent for cleaning the instrument. Do not use abrasives or solvents.

○ Working voltage is specified according to each Measurement category, which is defined in safety standards. It is to protect the user from transient impulse, which presents in the circuit under test. Measurement categories are defined as follows.

CAT. I : Secondary electrical circuits connected to an AC electrical outlet through a transformer or similar device.

CAT. II : Primary electrical circuits of equipment connected to an AC electrical outlet by a power cord.

CAT. III : Primary electrical circuits of the equipment connected directly to the switchboard, and feeders from the distribution panel to outlets.

CAT. IV : The circuit from the service drop to the service entrance, and to the power meter and primary over-current protection device (switchboard).

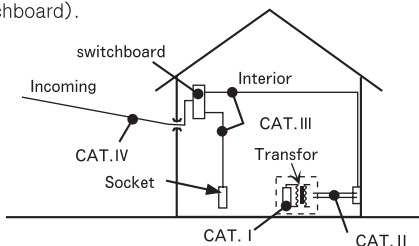

2. Features

KEW SNAP 2037 is a microprocessor-controlled digital clamp meter designed for testing and maintaining distribution lines, in-house wiring and electrical appliances with voltages up to 600V.

KEW SNAP 2037 provides:

- Designed to meet the following safety standards.
 - IEC61010-1 measurement category (CAT.) III 600V
 - IEC61010-2-032 (Hand-held current sensors)
 - IEC61010-031 (Probe assemblies)
- Accurate true RMS readings of AC current and voltage regardless of the waveform.
- LoHz mode that automatically selects a lower sample rate in low frequency measurement to reduce fluctuations of display readings.
- Sleep function to save battery.
- Data Hold function to freeze readings on the digital display. This allows for easy reading in dimly lit or hard-to-reach locations.
- "Peak" function to measure current or voltage peaks.
- "Average" function to allow for easy reading of fluctuating current or voltage.
- "Auto-null" function to allow for easy zero adjustment.
- Frequency measurement function.
- Digital display with maximum counts of 4000.
- Automatic display range selection in current, voltage and resistance measurement.

3. Specifications

Measuring Ranges and Accuracy (at $23\pm 5^{\circ}\text{C}$, 45–75% relative humidity)

DC Current $\overline{\text{---}}$ A

Measuring Range (Auto-ranging)	0–399.9A/150–1000A
Accuracy	$\pm 1.0\% \text{rdg} \pm 5 \text{dgt}$

After the instrument is powered up, it is in the Lo range.

Lo : 0–399.9A (Shifts to Hi when reading rises above 400.0A)

Hi : 150–1000A (Shifts to Lo when reading falls below 150A.)

OL appears when reading exceeds 1020A.)

AC Current \sim A (Crest factor(CF) : 3.0 or less)

Measuring Range (Auto-ranging)	0–399.9A/150–600A
Accuracy	$\pm 1.5\% \text{rdg} \pm 5 \text{dgt}$ (50/60Hz) $\pm 3.5\% \text{rdg} \pm 5 \text{dgt}$ (40–1kHz)

After the instrument is powered up, it is in the Lo range.

Lo : 0–399.9A (Shifts to Hi when reading rises above 400.0A)

Hi : 150–600A (Shifts to Lo when reading falls below 150A.)

OL appears when reading exceeds 620A.)

DC Voltage $\overline{\text{---}}$ V

Measuring Range (Auto-ranging)	0–39.99V/15.0–399.9V/150–600V
Accuracy	$\pm 1.0\% \text{rdg} \pm 5 \text{dgt}$
Input Impedance	$2\text{M}\Omega$

After the instrument is powered up, it is in the Lo range.

Lo : 0–39.99V (Shifts to Mid when reading is 40.00V or greater)

Mid : 15.0–399.9V (Shifts to Hi when reading rises above 400.0V,
and to Lo when reading falls below 15.0V.)

Hi : 150–600V (Shifts to Mid when the reading falls below 150V.)

OL appears when the reading exceeds 620V.)

AC Voltage \sim V (Crest factor (CF) : 3.0 or less)

Measuring Range (Auto-ranging)	0-39.99V/15.0-399.9V/150-600V
Accuracy	$\pm 1.5\%rdg \pm 5dgt$ (50/60Hz) $\pm 3.5\%rdg \pm 5dgt$ (40-1kHz)
Input Impedance	2M Ω

After the instrument is powered up, it is in the Lo range.

Lo : 0–39.99V (Shifts to Mid when reading rises above 40.00V.)

Mid : 15.0–399.9V (Shifts to Hi when reading rises above 400.0V,
and to Lo when reading falls below 15.0V.)

Hi : 150–600V (Shifts to Mid when reading falls below 150V.)

OL appears when reading exceeds 620V.)

Resistance Ω

Measuring Range (Auto-ranging)	0–399.9 Ω /150–3999 Ω
Accuracy	$\pm 1.0\%rdg \pm 5dgt$

After the instrument is powered up, it is in the Lo range.

Lo : 0–399.9 Ω (Shifts to Hi range when reading rises above 400.0 Ω).

Hi : 150–3999 Ω (Shifts to Lo when the reading falls below 150 Ω .)

OL appears when reading exceeds 3999 Ω .)

Continuity Check \Rightarrow)

Measuring Range	0–399.9 Ω
Accuracy	$\pm 1.0\%rdg \pm 5dgt$

If the resistance is 20.0 Ω or less, the buzzer sounds a series of beeps.

Frequency



Measuring Range	10–3000Hz
Accuracy	$\pm 1.5\%rdg \pm 5dgt$

Effective Value (RMS)

Most alternating currents and voltages are expressed in effective values, which are also referred to as RMS(Root-Mean-Square) values.

The effective value is the square root of the average of square of alternating current or voltage values.

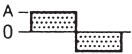
Many clamp meters with rectifier type circuits have scales that are calibrated in RMS values for AC measurements. But, they actually measure the average value of input voltage or current and depend on the voltage or current to be a sine wave. The conversion factor for a sine wave, which is found by dividing the effective value by the average value, is 1.1. These instruments are in error if the input voltage or current has some other shape than a sine wave.

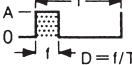
Waveform	Effective value V_{ms}	Average value V_{avg}	Conversion factor V_{ms}/V_{avg}	Reading errors for average sensing instruments	Crest factor CF
 <p>A sine wave with peak value A and average value $\frac{2}{\pi}A$. The area under the curve is shaded.</p>	$\frac{1}{\sqrt{2}} A$ ≈ 0.707	$\frac{2}{\pi} A$ ≈ 0.637	$\frac{\pi}{2\sqrt{2}}$ ≈ 1.111	0%	$\sqrt{2}$ ≈ 1.414
 <p>A square wave with peak value A and average value A. The area under the curve is shaded.</p>	A	A	1	$\frac{A \times 1.111 - A}{A} \times 100$ $= 11.1\%$	1
 <p>A triangular wave with peak value A and average value $\frac{1}{3}A$. The area under the curve is shaded.</p>	$\frac{1}{\sqrt{3}} A$	0.5A	$\frac{2}{\sqrt{3}}$ ≈ 1.155	$\frac{0.5A \times 1.111 - \frac{A}{\sqrt{3}}}{\frac{A}{\sqrt{3}}} \times 100$ $= -3.8\%$	$\sqrt{3}$ ≈ 1.732
 <p>A pulse wave with peak value A, pulse width T, and period D. The area under the curve is shaded. $D = 1/T$.</p>	$A\sqrt{D}$	$A \frac{f}{T}$ $= A \cdot D$	$\frac{A\sqrt{D}}{AD} = \frac{1}{\sqrt{D}}$	$(1.111\sqrt{D} - 1) \times 100\%$	$\frac{A}{A\sqrt{D}} = \frac{1}{\sqrt{D}}$

CF : Crest Factor = Peak value / Effective value

DC : 1

Sine wave : 1.414

Square wave with a duty ratio 1 : 10 : 3

Operating System: Dual Integration

Display: Liquid crystal display with maximum reading of 3999

Overrange Indication: "OL" is indicated on the display.

Response Time: Approx. 2 seconds

Sample Rate: Approx. 3 times per second

Location for use	Altitude up to 2000m, in-door use	
Operating Temperature and Humidity:	0~40°C at 90% max. relative humidity without condensation	
Storage Temperature and Humidity:	-10°C~50°C at 75% max. relative humidity without condensation	
Power Source:	6F22(DC9V) or equivalent	
Current Consumption:	Approx. 15mA	
Sleep Function:	Shuts off in about 30 minutes after power-up	
Overload Protection:	DCA, ACA ranges : Up to AC/DC1000A DCV, ACV ranges : Up to AC/DC1000V Resistance range : Up to AC/DC600V	
Withstand Voltage:	5550VAC for 1 minute between electrical circuit and housing case as well as electrical circuit and transformer jaws	
Insulation Resistance:	10MΩ min. at 1000V between electrical circuit and housing case as well as between electrical circuit and transformer jaws	
Conductor Size:	Approx. 33mm diameter max.	
Dimensions:	208(L)×91(W)×40(D)mm	
Weight:	450g approx.	
Standards (Safety)	IEC61010-1 Measurement CAT. III 600V pollution degree 2 IEC61010-2-032 (Hand-held current sensors) IEC61010-031 (Probe assemblies)	
Accessories:	Test Leads	Model 7066
	Battery	6F22(9V)
	Carrying Case	Model 9079
	Instruction manual	
Optional Accessories:	Multi-Tran Model 8004 and 8008 (These models are not for DC measurements)	

4. Instrument Layout

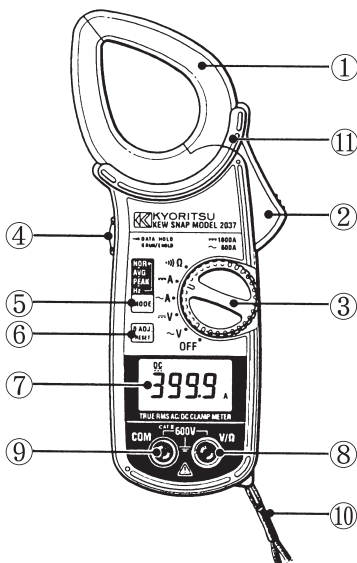

①Transformer Jaws

Pick up current flowing through the conductor.

②Jaw Trigger

Operates the transformer jaws. Press to open the Transformer Jaws.

③Function Selector Switch

Selects function. It is also used to turn power on.

④Data Hold Push Button

Freezes the display reading. "**H**" is shown on the digital display when Data Hold is enabled.

⑤ Mode Selector Switch (See sections 6-6 to 6-8)

Selects measuring mode. Press this switch to cycle through measuring modes. The instrument is in the normal mode (NOR) after it is powered up. In any mode, pressing this switch for more than one second returns the instrument to the NOR mode.

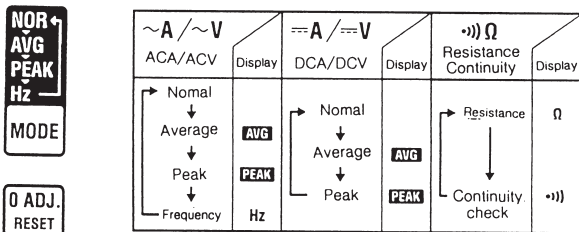

⑥ Zero Adjust/Reset Switch

Used for zero adjustment on DCA and resistance ranges. On DCA range, "AUTO" is shown on the display to indicate auto-zeroing is completed. This switch is also used to reset the display reading in the Peak mode.

⑦ Digital Display

Field effect digital display with maximum reading of 3999. Function symbols and decimal point are displayed according to selected function and mode.

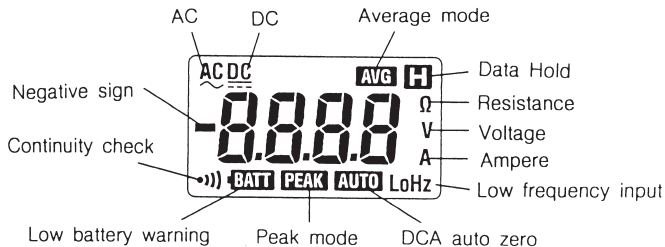

⑧V/Ω Terminal

Accepts the red test lead for voltage or resistance measurement.

⑨COM Terminal

Accepts the black test lead for voltage or resistance measurement.

⑩Safety Hand Strap

Prevents the instrument from slipping off the hand during use.

⑪Barrier

It is a part providing protection against electrical shock and ensuring the minimum required air and creepage distances.

5. Preparations for Tests

- (1) To check battery voltage, set the Function Selector Switch to the ON position.

If the display is clear without symbol "BATT" showing, battery voltage is OK. If the display blanks or "BATT" is indicated, replace the battery according to section 8 for Battery Replacement.

NOTE:

The instrument automatically switch to the sleep (power off) mode if no switch is operated for approximately 30 minutes. Therefore, the display may be blank with the Function Selector Switch set to the On position. To operate the instrument, set the switch back to the OFF position, then to the ON position again.

- (2) If the Data Hold Switch is pressed in (Data Hold mode), press to release it. Otherwise, the display reading remains frozen. When the instrument is in the Data Hold mode, "H" symbol is indicated on the display.
- (3) Make sure that the instrument is in the desired measuring mode.

6. Operating Instructions

6-1 DC Current Measurements

⚠WARNING

- Never clamp around a conductor with 600V or higher.
- Doing so may cause electrical shock hazard and damage to the instrument or the circuit under test.
- Do not make measurement with the test leads plugged into the instrument.
- Do not make measurement with the battery compartment cover removed.
- Keep your fingers and hands behind the barrier during measurement.

- (1) Set the Function Selector Switch to the $\overline{\text{A}}$ "A" position.
- (2) With the Transformer Jaws closed, press the Zero Adjust Switch until the display reads zero with symbol "AUTO" showing.
- (3) Press the trigger to open the transformer jaws and clamp onto a conductor. The most accurate reading will be obtained by keeping the conductor at the center of the transformer jaws.

NOTE:

- During current measurement, keep the transformer jaws fully closed.
- Otherwise, accurate measurements cannot be taken. Maximum conductor size is 33 mm in diameter.
- Polarity of display reading is indicated as positive when current flows from the frontside to backside of the instrument.

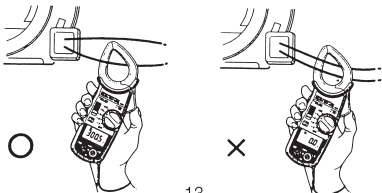

6-2 AC Current Measurements

⚠WARNING

- Never clamp around a conductor with 600V or higher.
- Doing so may cause electrical shock hazard and damage to the instrument or the circuit under test.
- Do not make measurement with the test leads plugged into the instrument.
- Do not make measurement with the battery compartment cover removed.
- Keep your fingers and hands behind the barrier during measurement.

- (1) Set the Function Selector Switch to the " \sim A" position.
- (2) Press the trigger to open the transformer jaws and clamp onto a conductor.

The most accurate reading will be obtained by keeping the conductor at the center of the transformer jaws.

NOTE:

- During current measurements, keep the transformer jaws fully closed. Otherwise, accurate measurements cannot be taken. Maximum conductor size is 33 mm in diameter.
- Zero adjustment is not necessary in AC current measurements.
- When the reading of input current is 3% of full scale or less in the circuit under test or the frequency of current is low, symbol "LoHz" is indicated on the display.

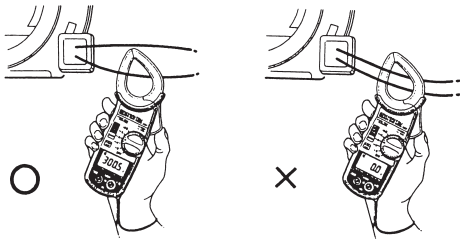

6-3 DC Voltage Measurements

⚠ WARNING

- Never use the instrument on a high voltage circuit with 600V or higher.
- Doing so may cause electrical shock hazard and damage to the instrument or the circuit under test.
- Do not make measurement with the battery compartment cover removed.
- Keep your fingers and hands behind the barrier during measurement.

- (1) Set the Function Selector Switch to the " $\text{---}V$ " position.
- (2) Plug the red test lead into the V/Ω terminal and the black test lead into the COM terminal.
- (3) Connect the red and black test leads to the positive (+) and negative (-) sides of the circuit under test respectively. If the connection is reversed, the display indicates "- " sign.

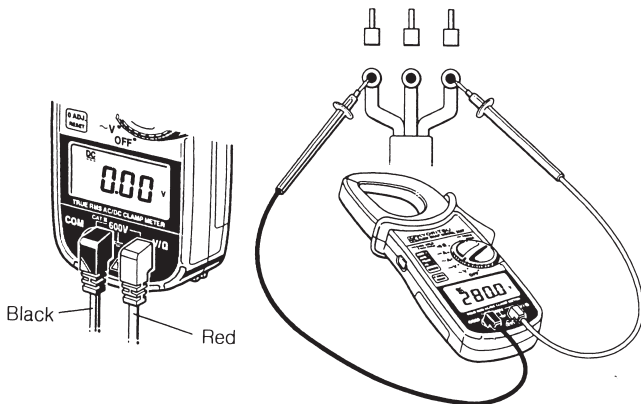

6-4 AC Voltage Measurements

⚠ WARNING

- Never use the instrument on a high voltage circuit with 600V or higher.
- Doing so may cause electrical shock hazard and damage to the instrument or the circuit under test.
- Do not make measurement with the battery compartment cover removed.
- Keep your fingers and hands behind the barrier during measurement.

- (1) Set the Function Selector Switch to the " \sim V" position.
- (2) Plug the red test lead into the V/ Ω terminal and the black test lead into the COM terminal.
- (3) Connect the red and black test leads to the circuit under test.
Polarity of the test leads may be disregarded.

NOTE:

- When the reading of input voltage is 3% of full scale or less in the circuit under test or the frequency of voltage is low, symbol "LoHz" is indicated on the display.

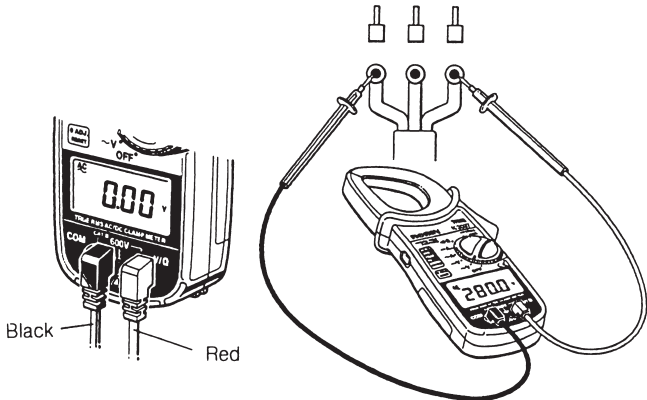

6-5 Resistance Measurement

⚠ WARNING

- Never use the instrument on an energized circuit to avoid possible electrical shock hazard and damage to the instrument or the circuit under test.
- Do not make measurement with the battery compartment cover removed.
- Keep your fingers and hands behind the barrier during.

- (1) Set the Function Selector Switch to the " Ω " position.
- (2) Plug the red test lead into the V/ Ω terminal and the black test lead into the COM terminal.
- (3) With the tips of the test leads shorted together, press the Zero Adjust Switch to offset the resistance of the test leads.
- (4) Connect the test leads to the circuit under test.

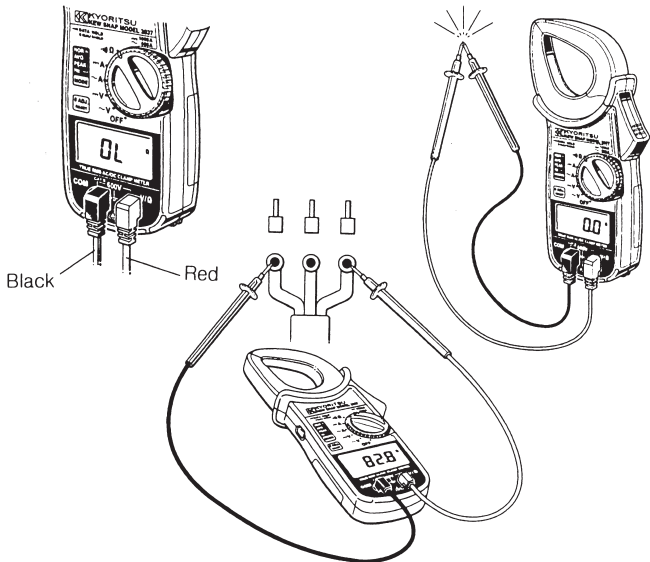

6-6 Continuity Check

- Continuity check mode is enabled by pressing the Mode Selector Switch while the instrument is in resistance range.
- Symbol "••)" is indicated on the display to show the instrument in the continuity check mode.
- The buzzer sounds, if the resistance under test is 20.0Ω or less. (Measuring range is fixed at 400Ω .)

⚠WARNING

- **Never use the instrument on an energized circuit to avoid possible electrical shock hazard and damage to the instrument or the circuit under test.**
- **Do not make measurement with the battery compartment cover removed.**
- **Keep your fingers and hands behind the barrier during measurement.**

- (1) Set the Function Selector Switch to the "••)" Ω position.
- (2) Plug the red test lead into the V/Ω terminal and the black test lead into the COM terminal.
- (3) With the tips of the test leads shorted together, press the Zero Adjust Switch to offset the resistance of the test leads.
- (4) Press the Mode Selector Switch once to switch from the normal mode to the continuity check mode. Symbol "••)" is indicated on the display.
- (5) Connect the tips of the test leads to the circuit under test. If the resistance is 20.0Ω or less, the buzzer sounds a series of beeps.

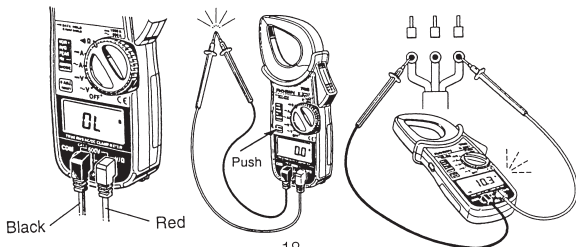

6-7 Frequency Measurement

- Frequency measurement mode is enabled by pressing the Mode Selector Switch while the instrument is in ACV or ACA range.
- Symbol "Hz" is indicated on the display to show the instrument in the frequency measurement mode.
- Trigger threshold is 10% of full scale.

⚠WARNING

- **Never use the instrument on a high voltage circuit with 600V or higher.**
- **Doing so may cause electrical shock hazard and damage to the instrument or the circuit under test.**
- **Do not make measurement with the battery compartment cover removed.**
- **Keep your fingers and hands behind the barrier during measurement.**

- (1) Set the Function Selector Switch to the " \sim A" or " \sim V" position.
- (2) Press the Mode Selector Switch three times to switch from the normal mode to the Frequency measurement mode. Symbol "Hz" is indicated on the display.
- (3) Follow procedures for ACA or ACV measurement.

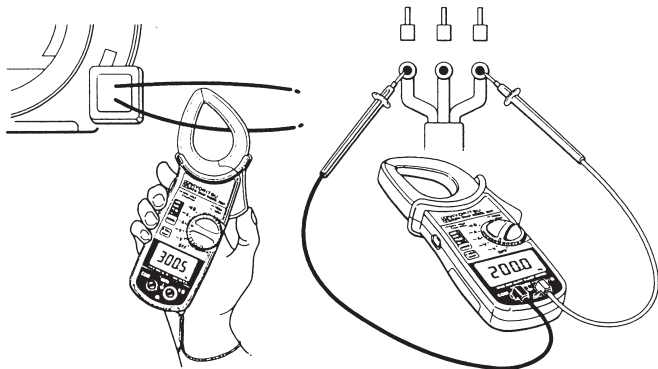

6-8 Peak Measurement

- Symbol "**PEAK**" is indicated on the display during the instrument is in the Peak measurement mode.
- In this mode, the display reads maximum current or voltage in RMS (1/2 of the half-cycle peak ampere or voltage in case of a sine wave) and updates reading.
- Response time: 200ms for DC measurements, 500ms for AC measurements.

⚠WARNING

- **Never use the instrument on a high voltage circuit with 600V or higher.**
- **Doing so may cause electrical shock hazard and damage to the instrument or the circuit under test.**
- **Do not make measurement with the battery compartment cover removed.**
- **Keep your fingers and hands behind the barrier during measurement.**

- (1) The Peak measurement mode is available for ACV, DCV, ACA and DCA readings. Set the Function Selector Switch to the " \sim A", " --- A", " \sim V" or " --- V" position.
- (2) Press the Mode Selector Switch twice to switch from the normal mode to the peak measurement mode. Symbol "**PEAK**" is indicated on the display.
- (3) Follow procedures for ACA or ACV measurement.
- (4) Press the Reset Switch before starting peak measurement for accurate readings.

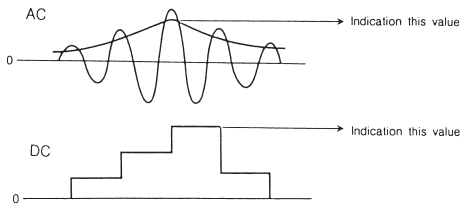

NOTE:

- In AC measurement, readings are calibrated in RMS values.
- In DC measurement, the Peak mode is available only for positive readings.
- In the peak measurement mode, measuring range is fixed at Hi.

6-9 Average Measurement.

- Symbol "**AVG**" is indicated on the display when the instrument is in the Average measurement mode.
 - In this mode, the display reads a running average of six readings over an interval of about 2 seconds.
- (1) The average measurement mode is available for ACV, DCV, ACA and DCA readings. Set the Function Selector Switch to the " $\sim A$ ", " $\sim A$ ", " $\sim V$ " or " $\sim V$ " position.
 - (2) Press the Mode Selector Switch once to switch from the normal mode to the average measurement mode. Symbol "**AVG**" is indicated on the display.
 - (3) Follow procedures for ACV, DCV, ACA or DCA measurement.
 - (4) The display reads a running average of six readings over an interval of about 2 seconds.

7. Other Functions

7-1 Sleep

If the Function Selector Switch or other switches are not pressed for about 30 minutes, the instrument automatically enters the sleep (power off) mode to save battery. To turn on the instrument, set the Function Selector Switch to the OFF position, then select the desired function.

NOTE:

There is a small current drain even in the sleep mode. Make sure to set the Function Selector Switch to the OFF position after use.

7-2 Data Hold

While making measurement, press the Data Hold button. Display reading is frozen with "**H**" symbol indicated. Press Data Hold button again to exit from the Data Hold mode.

7-3 LoHz

In ACV or ACA measurement, if frequency of input voltage or current is 40Hz or lower, the display indicates symbol "LoHz" and sample rate is switched from the normal 3 times per second to two times per second to reduce fluctuations of readings.

Symbol "LoHz" is also indicated where the reading of input voltage or current is 3% of full scale or less. There is no voltage or current input.

8. Battery Replacement

When "**BATT**" is indicated on the bottom left corner of the display, the battery replacement is necessary. Note that if the battery has completely worn out, the display neither indicates "**BATT**" nor any other symbols.

- (1) Set the Function Selector Switch to the OFF position.
- (2) Unscrew and remove the battery compartment cover.
- (3) Replace the battery with a new 9V battery (type 6F22 or equivalent).
- (4) Put the battery compartment cover in place and tighten the screw.

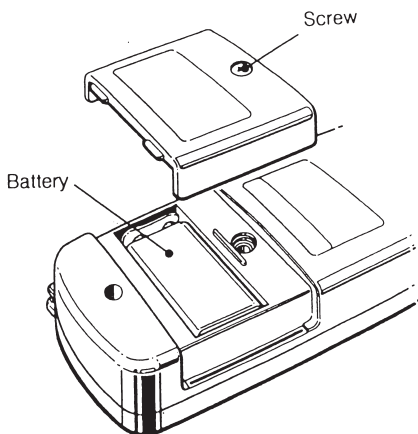

9. Optional Accessories

Model 8004 and 8008 (Multi-Tran)

NOTE: These models are not for DC measurement.

Model 8008 is a clamp-on current transformer designed to measure AC current up to 3,000A in conjunction with a clamp meter.

It clamps on large bus-bars (up to 150×100mm) and conductors (up to 100mm diameter).

Model 8004 is also available for measuring AC current up to 1,000A on a conductor of max. 60mm diameter. As shown, clamp on a conductor with Model 8008 or 8004, with their pickup coil also clamped with KEW SNAP 2037. Take reading and multiply it by 10.

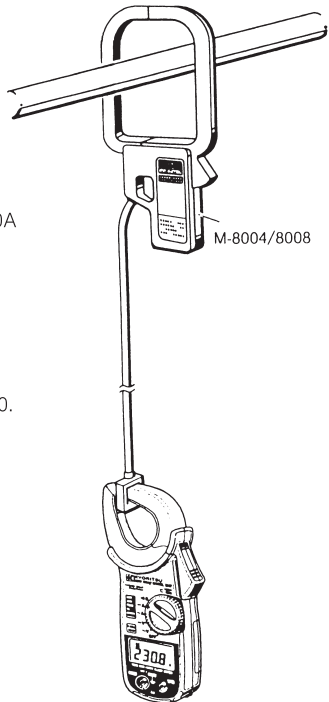

Memo

Kyoritsu reserves the right to improve specifications and designs without notice and without obligations.

Quality and reliability is our tradition

DISTRIBUTOR

10-07

92-1330D



**KYORITSU ELECTRICAL
INSTRUMENTS
WORKS, LTD.**

No.5-20,Nakane 2-chome, Meguro-ku,
Tokyo, 152-0031 Japan
Phone: +81-3-3723-0131
Fax: +81-3-3723-0152
Factory: Ehime

www.kew-ltd.co.jp

PRINTED IN JAPAN